

# HORPE

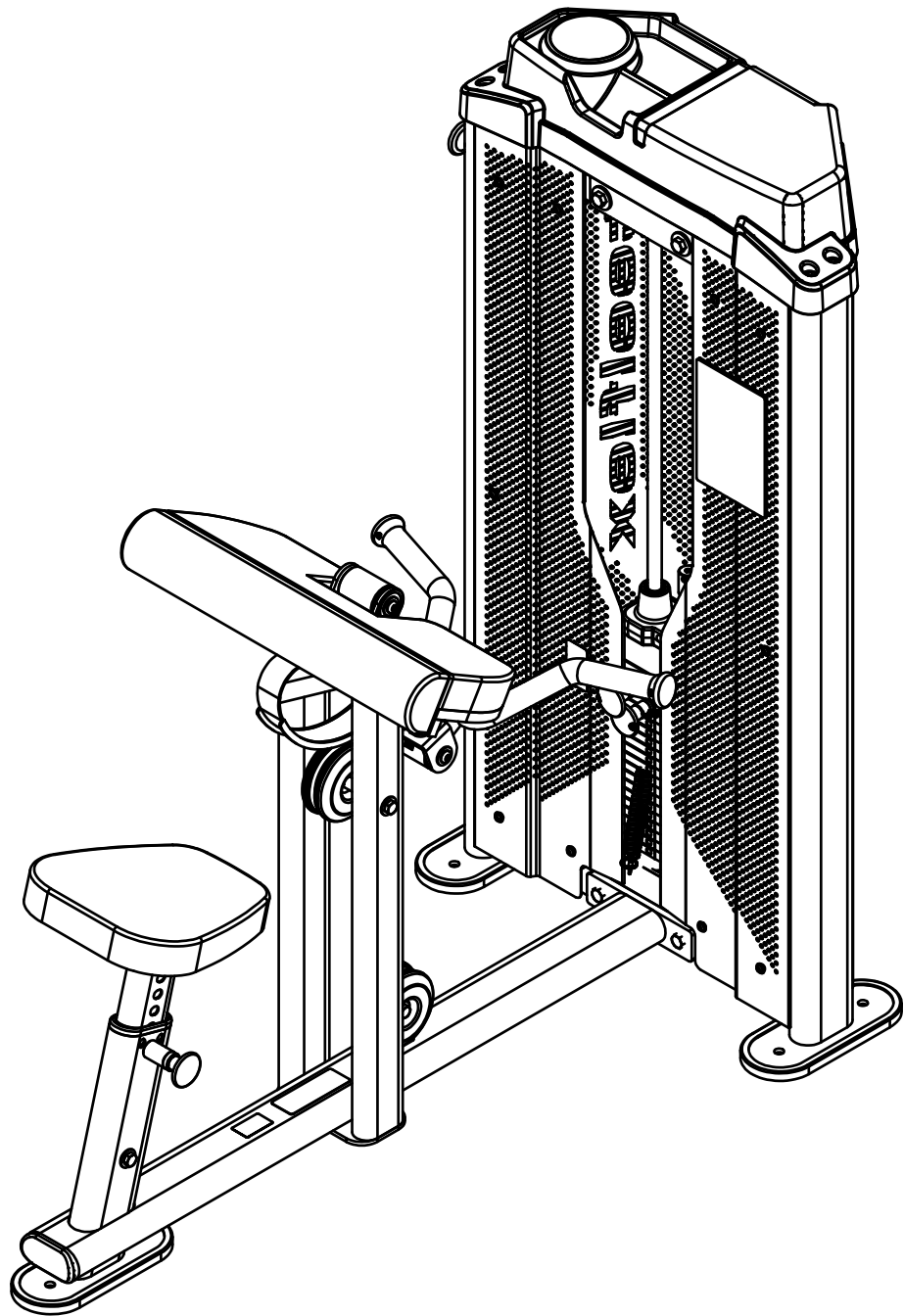

**Steelflex**

JOONG CHENN INDUSTRY CO., LTD.

Sales Office:

3F28, No.5, Shin-Yi Rd., Sec. 5, Taipei, Taiwan 110 R.O.C.

Tel: 886-2-27209980

Fax: 886-2-27229750

[www.steelflexfitness.com](http://www.steelflexfitness.com)

## HBC-600.2 OWNER'S MANUAL

# HBC-600 ASSEMBLY INSTRUCTIONS

## HARDWARE ILLUSTRATION

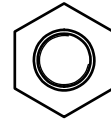
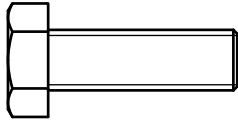

(A1)HEX BOLT M8X25L PARTIAL THREAD QTY.8

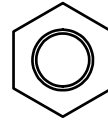
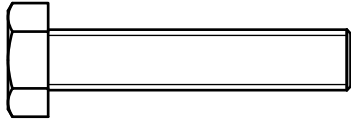

(A2)HEX BOLT M8X40L PARTIAL THREAD QTY.1

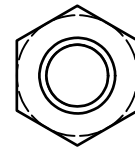
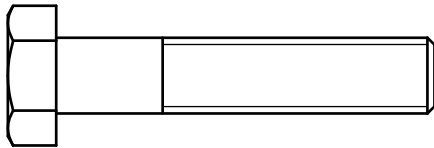

(A3)HEX BOLT M10X50L PARTIAL THREAD QTY.1

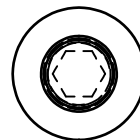
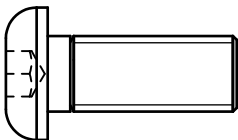

(A4)ROUND ALLEN HEAD M10x25L PARTIAL THREAD QTY.4

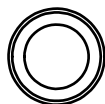
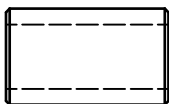

(A5)STEEL BUSHING Ø12XØ8.5X21L PARTIAL THREAD QTY.1

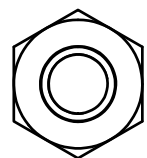
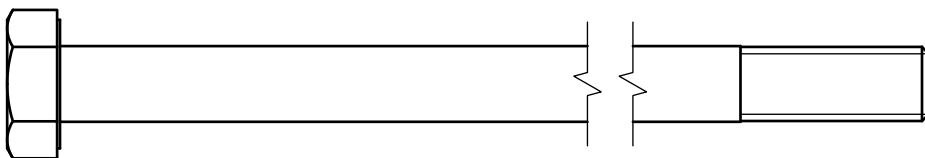

(A6)HEX BOLT M10X195L PARTIAL THREAD QTY.1

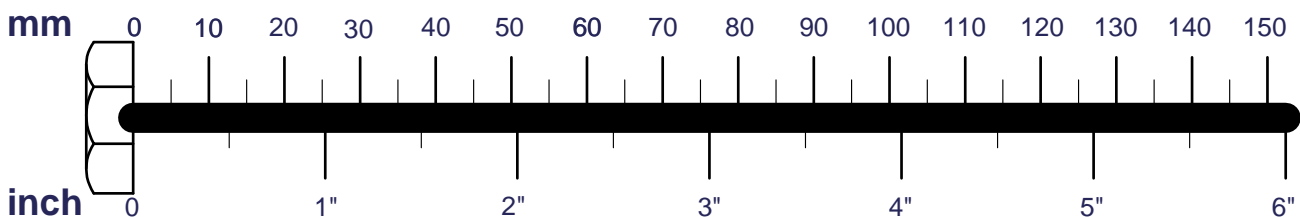

# HBC-600 ASSEMBLY INSTRUCTIONS

## FRAME HARDWARE ILLUSTRATION FOR HDA

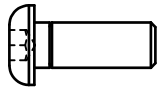

(A8) ROUND ALLEN HEAD M6X16L PARTIAL THREAD QTY.24

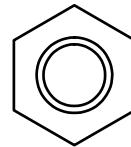
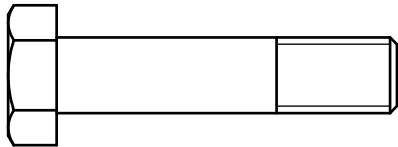

(A9) HEX BOLT M10X45L PARTIAL THREAD QTY.2

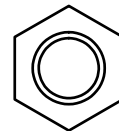
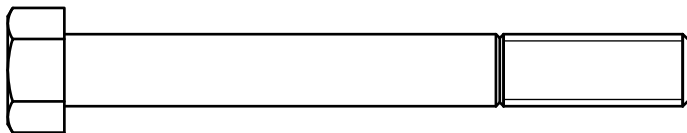

(A11) HEX BOLT 3/8"X2-3/4"L PARTIAL THREAD QTY.1

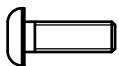

(A12) ROUND ALLEN HEAD M4X12L PARTIAL THREAD QTY.4

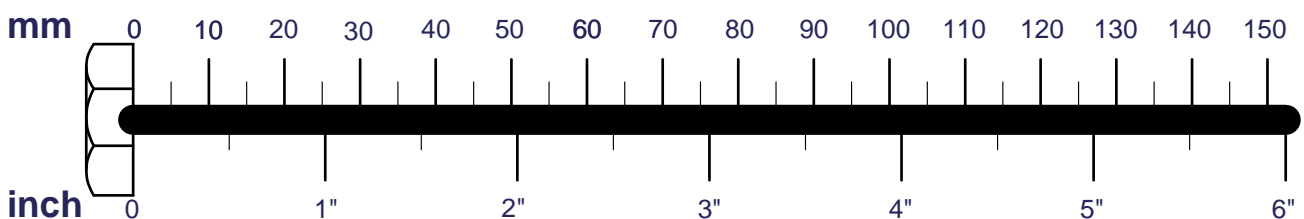

# HBC-600 ASSEMBLY INSTRUCTIONS

## FRAME HARDWARE ILLUSTRATION FOR HDA

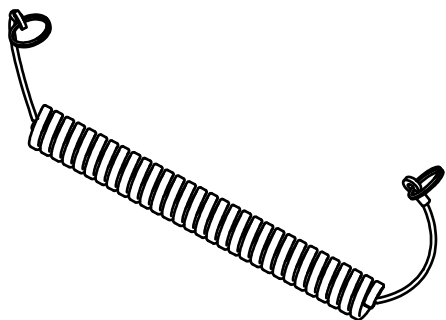

(A13)ELASTIC BELT (F920003) QTY.1

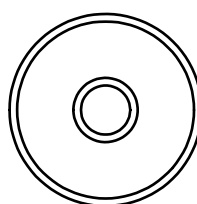
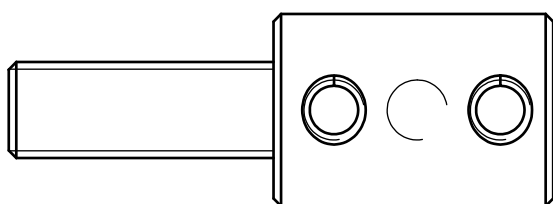

(A15)WEIGHT STACK CABLE (8260-009) QTY.1

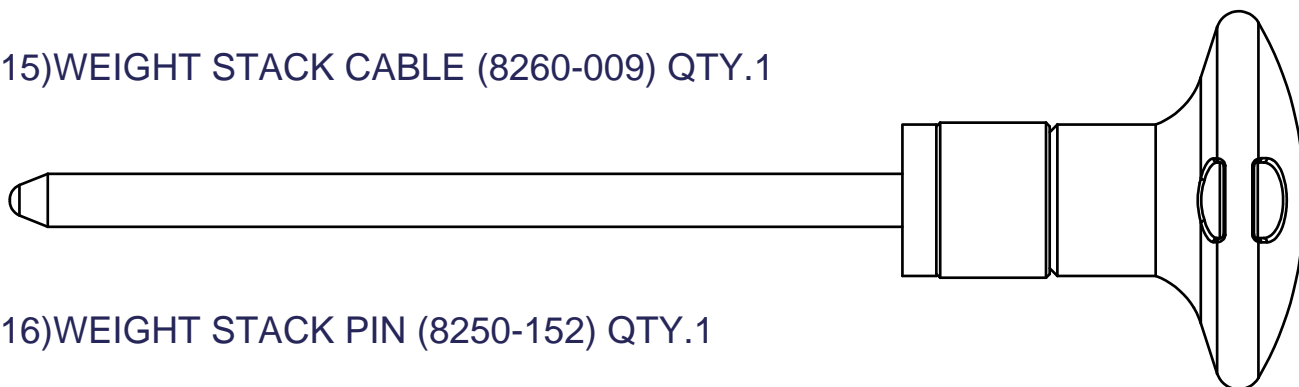

(A16)WEIGHT STACK PIN (8250-152) QTY.1

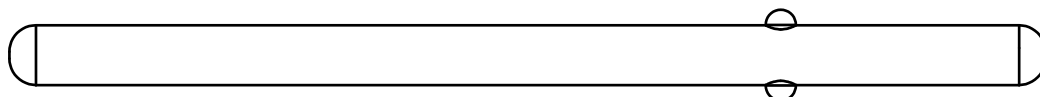

(A17)Ø5/16" FIXED PIN (8250-166) QTY.1

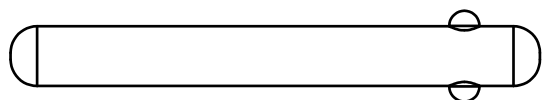

(A18)Ø5/16" FIXED PIN (8250-167) QTY.1

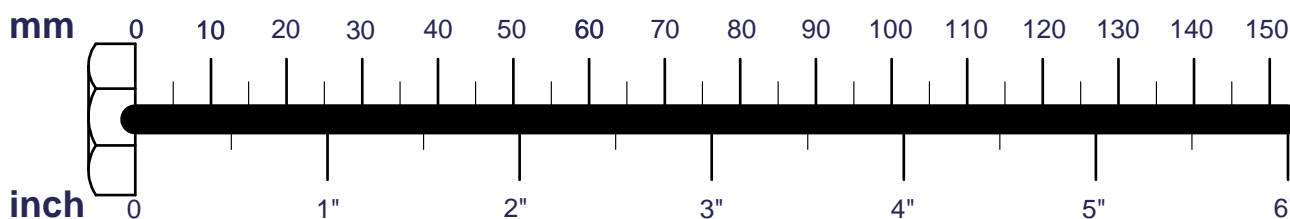

# HBC-600 ASSEMBLY INSTRUCTIONS

## HARDWARE ILLUSTRATION

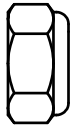

(B1) NYLON LOCK NUT M8 QTY.1

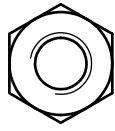

(B2) NYLON LOCK NUT M10 QTY.2

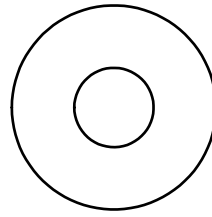

(C4) M10(I.D.) FLAT WASHER Ø27 QTY.8



(C5) M20(I.D.) FLAT WASHER Ø30 QTY.4

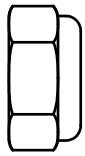

(C1) M8 SPRING WASHER QTY.8



(C2) M8(I.D.) FLAT WASHER Ø18 QTY.2

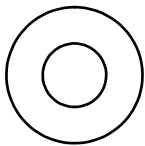

(C3) M8(I.D.) FLAT WASHER Ø24 QTY.8



mm

0 10 20 30 40 50 60 70 80 90 100 110 120 130 140 150

inch

0 1" 2" 3" 4" 5" 6"

# HBC-600 ASSEMBLY INSTRUCTIONS

## FRAME HARDWARE ILLUSTRATION FOR HDA

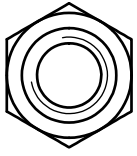

(B3) NYLON LOCK NUT M10 QTY.2

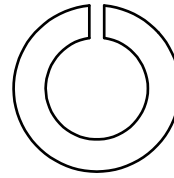
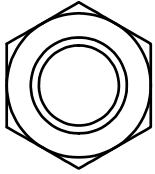

(B4) LOCK NUT 1/2" X 13 UNC QTY.1

(C11) 1/2" SPRING WASHER QTY.1



(B5) NYLON LOCK NUT M4 QTY.4

(C12) M4 (I.D.) FLAT WASHER Ø10 QTY.8

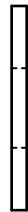
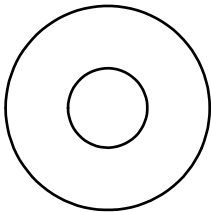

(C8) M10 (I.D.) FLAT WASHER Ø27 QTY.5

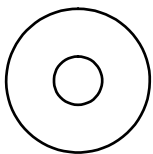

(C9) M6 (I.D.) FLAT WASHER Ø19 QTY.24

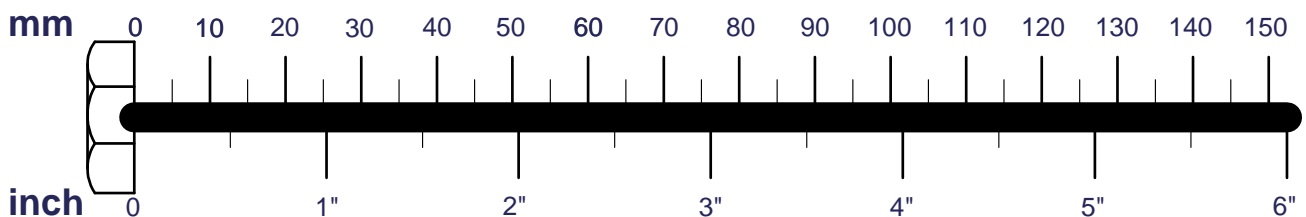

# HBC-600 ASSEMBLY INSTRUCTIONS

## HARDWARE ILLUSTRATION

D1.Ø3/4"X8L STEEL BUSHING (8110-014)	-----[2PCS]
D2.50X100 END CAP (9211-114)	-----[1PCS]
D3.38X4TX38L RUBBER PAD(9310-001)	-----[1PCS]
D4.108X14.5TX263L RUBBER PAD(9310-075)	-----[1PCS]
D6.Ø110 PULLEY(9213-002B)	-----[2PCS]
D7.3565mm BELT(FHBC600A1)	-----[1PCS]
D8.EXERCISE CHART (9420-082)	-----[1PCS]
D9.Ø5/8"X36L STEEL BUSHING (8110-132)	-----[2PCS]
D10.PLATE CAP(9211-173)	-----[4PCS]

D1



D2

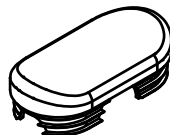

D3



D4

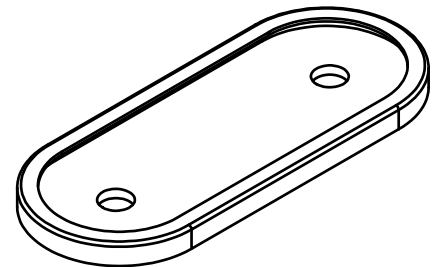

D6

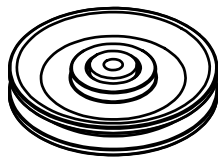

D7

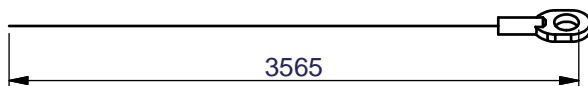

D9



D8

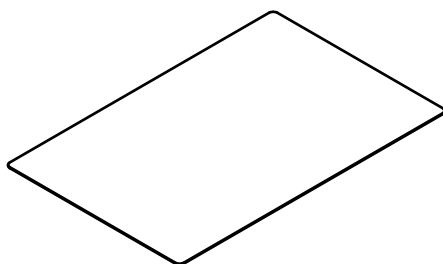

D10

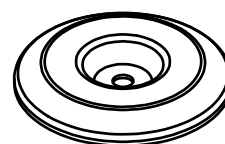

# HBC-600 ASSEMBLY INSTRUCTIONS

## FRAME HARDWARE ILLUSTRATION FOR HDA

D11.3/4" SHAFT COLLAR(9211-046)-----	[2PCS]
D12.2"x2" Rubber Cane Cap(9214-002)-----	[3PCS]
D13.Towel rack(9215-024)-----	[1PCS]
D14. Ø65XØ20X70L Rubber Dount(9310-049)-----	[2PCS]
D16.108X14.5TX263T RUBBER PAD(9310-075)-----	[2PCS]
D17.Ø110 PULLEY(9213-002B)-----	[2PCS]
D18.TOP PLATE(8400-006)-----	[1PCS]
D20.Selector Rod(8210-191)-----	[1PCS]

D11



D12

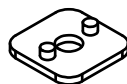

D13



D14

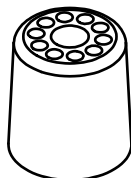

D16

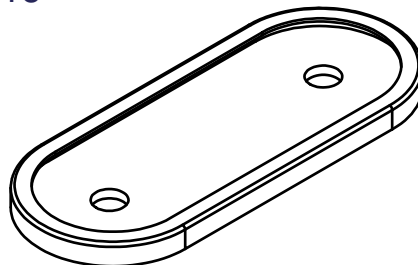

D17

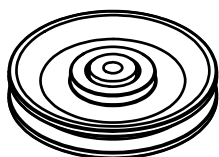

D18

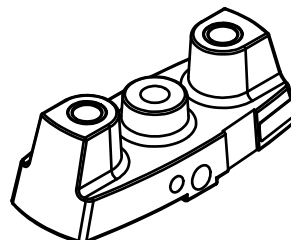

D20

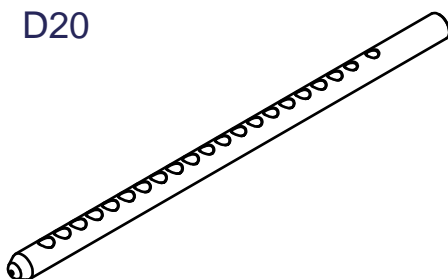



# HBC-600 ASSEMBLY INSTRUCTIONS

## PARTS ILLUSTRATION SHEET

A[1PCS]

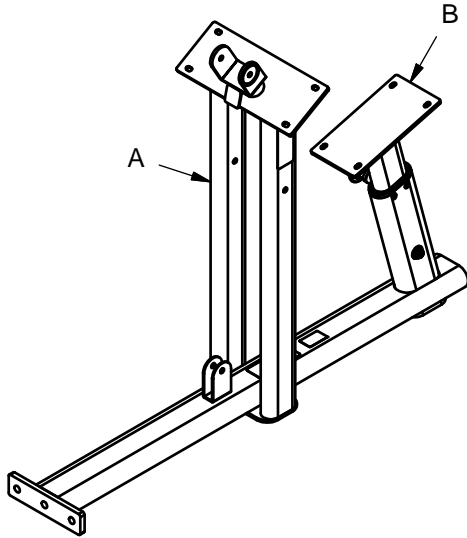

C[1PCS]

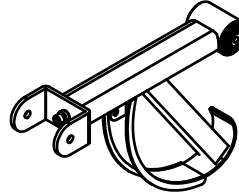

D[1PCS]

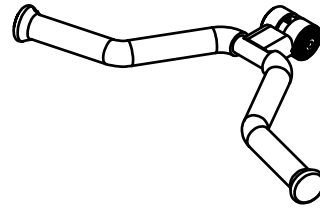

F[1PCS]  
8313-188

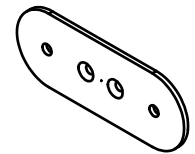
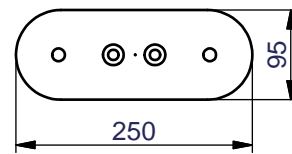

G[1PCS]  
9121-094

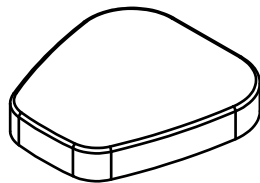
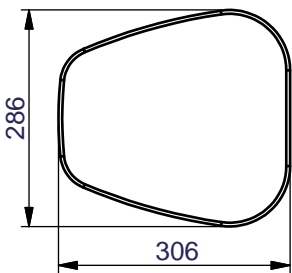

H[1PCS]  
9131-047

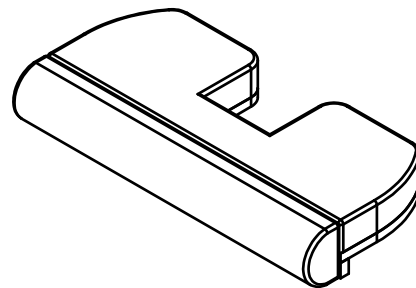

J[1PCS]  
8312-077

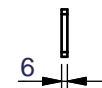
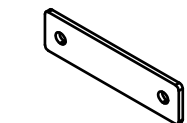
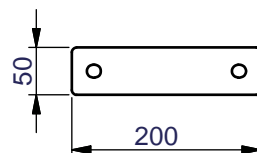

# HBC-600 ASSEMBLY INSTRUCTIONS

## FRAME PARTS ILLUSTRATION SHEET FOR HDA

AA[1PCS]  
6610-016

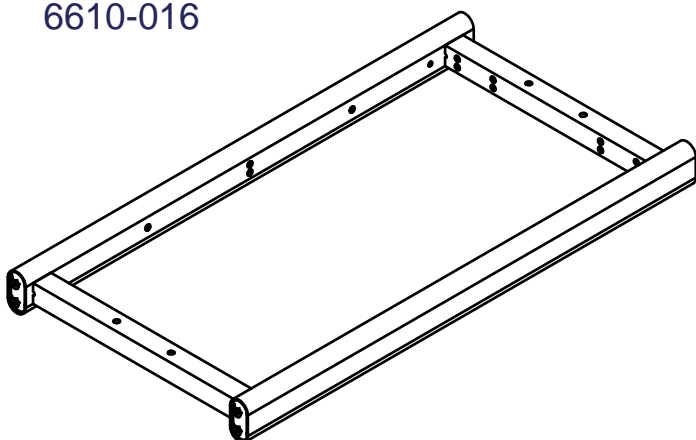

AB[1PCS]  
9211170-023

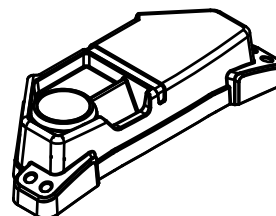

AC[1PCS]  
8380-066

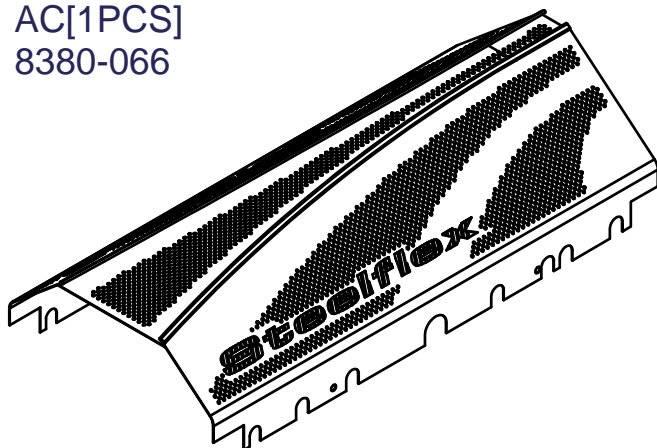

AD[1PCS]  
8380-067

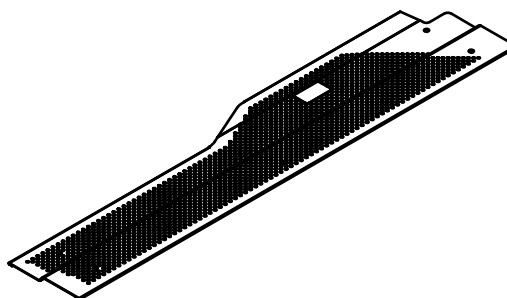

AE[1PCS]  
8380-068

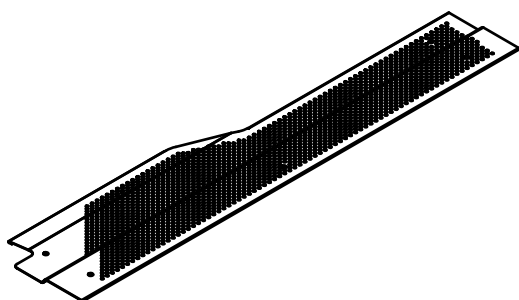

AF[1PCS]  
6610-017

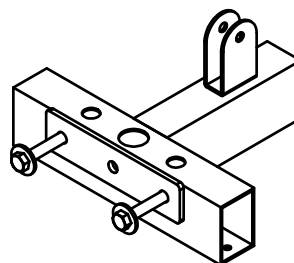

# HBC-600 ASSEMBLY INSTRUCTIONS

## FRAME PARTS ILLUSTRATION SHEET FOR HDA

AG[1PCS]  
6610-018

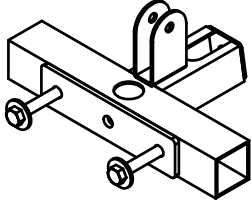

AH[4PCS]  
8331-065

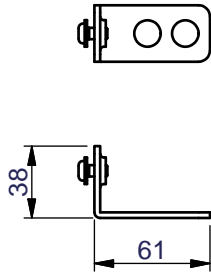

AI[6PCS]  
8331-064

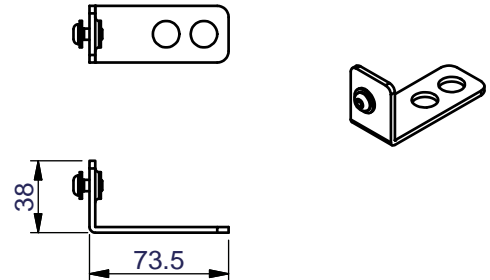

AJ[2PCS]  
8313-188

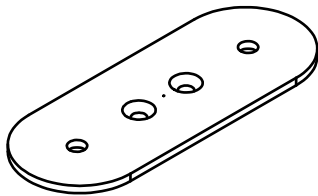

AK[1PCS]  
8331-017

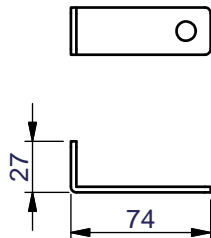

AL1[2PCS]  
8280-036  
Ø3/4"X1222L

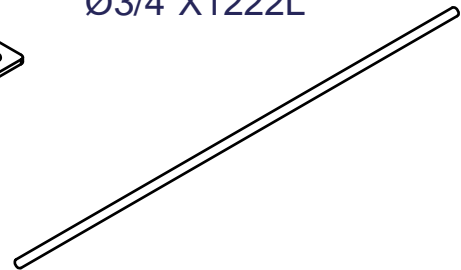

AN[1PCS]  
8345-014

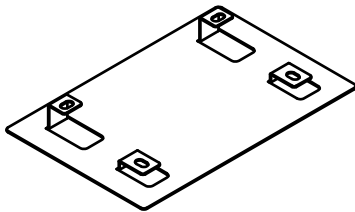

AO[2PCS]  
6670-004

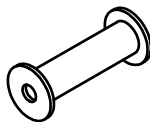

AP[1PCS]  
8311-194

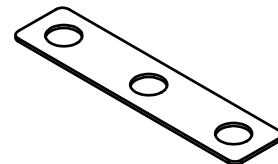

# HBC-600 ASSEMBLY INSTRUCTIONS

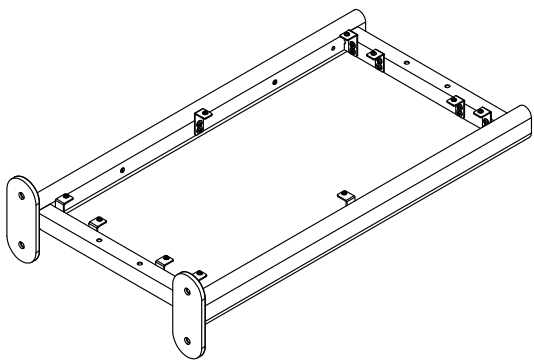

Above shows STEP 1 assembled and completed

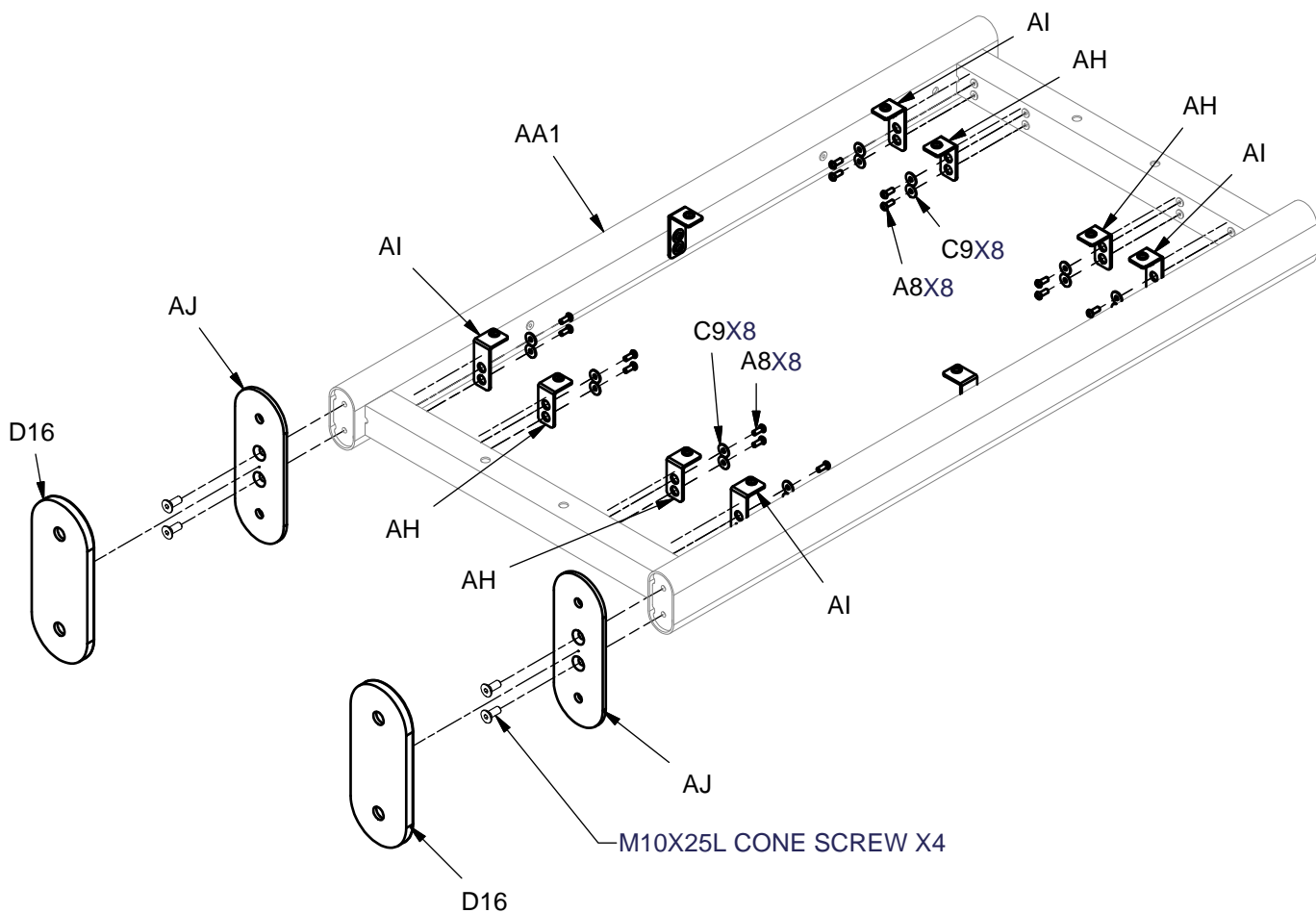

# HBC-600 ASSEMBLY INSTRUCTIONS

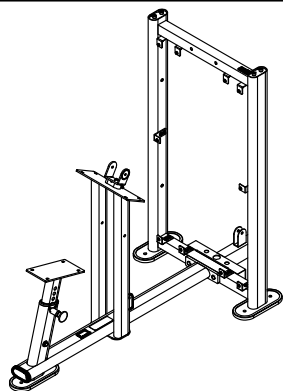

Above shows STEP 2  
assembled and completed

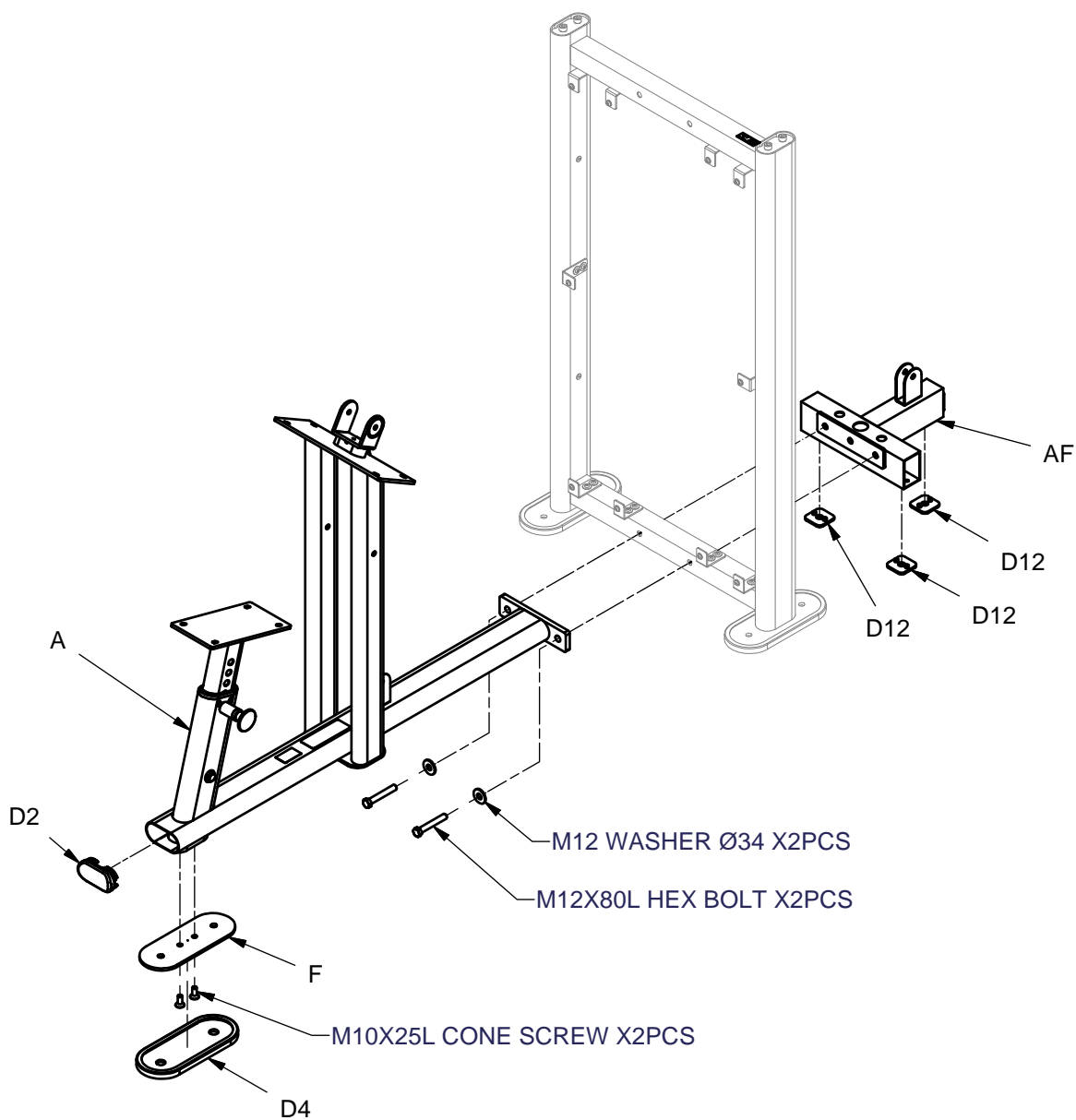

# HBC-600 ASSEMBLY INSTRUCTIONS

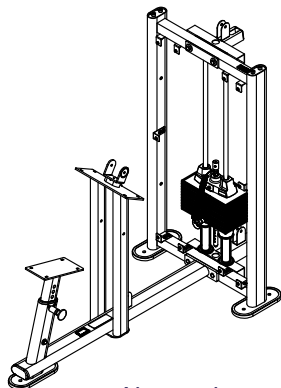

Above shows STEP 3 assembled and completed

M12 WASHER Ø34 X2PCS  
M12X80L HEX BOLT X2PCS

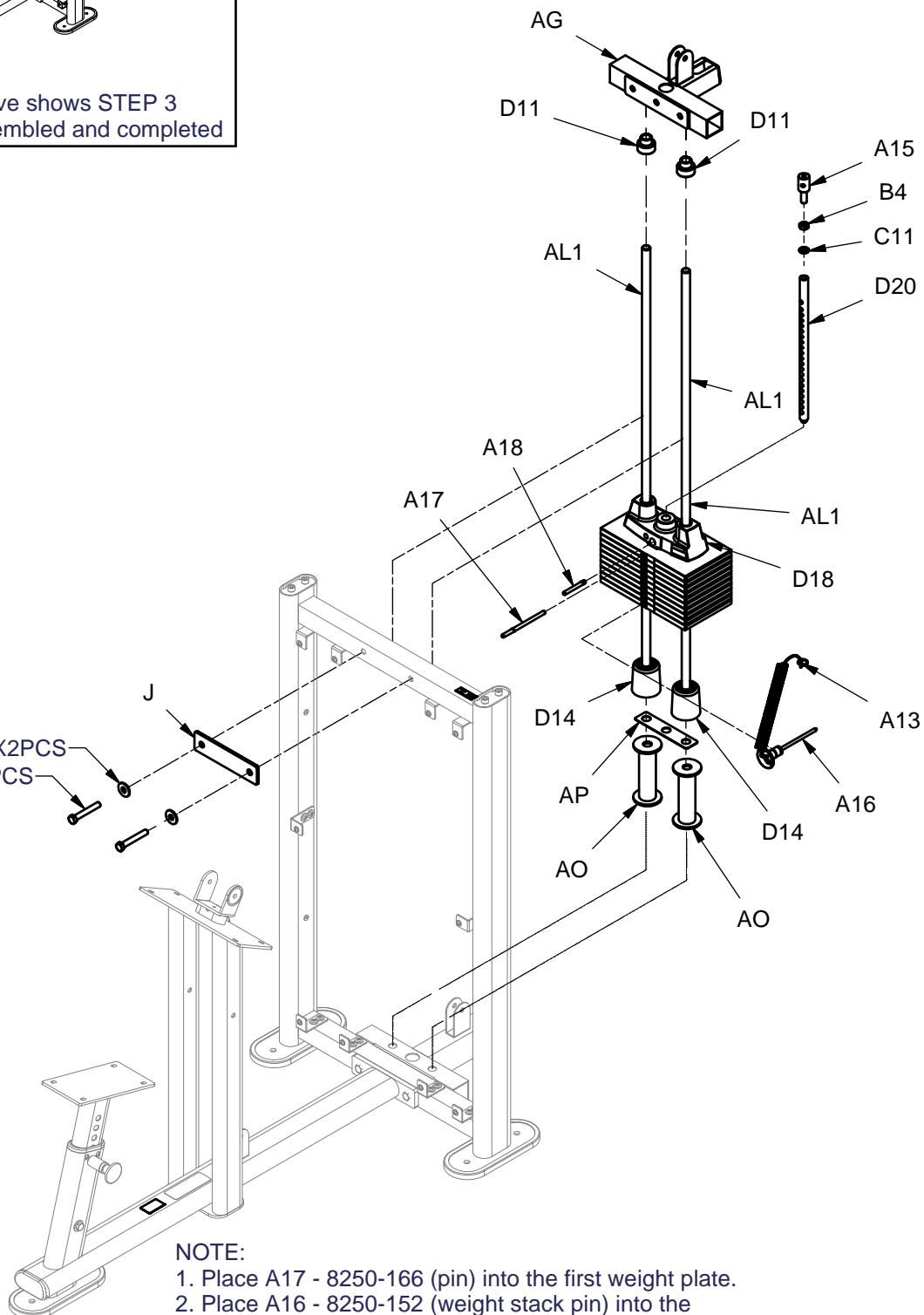

## NOTE:

1. Place A17 - 8250-166 (pin) into the first weight plate.
2. Place A16 - 8250-152 (weight stack pin) into the hole 20th of the weight stack.
3. Make sure D18- 8400-006A(top plate) cling to (first weight plate) and fix in A18 - 8250-167(pin).
4. Finally remove A16 - 8250-152 (weight stack pin) and use as usual.

# HBC-600 ASSEMBLY INSTRUCTIONS

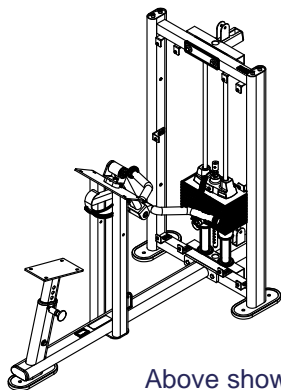

Above shows STEP 4 assembled and completed

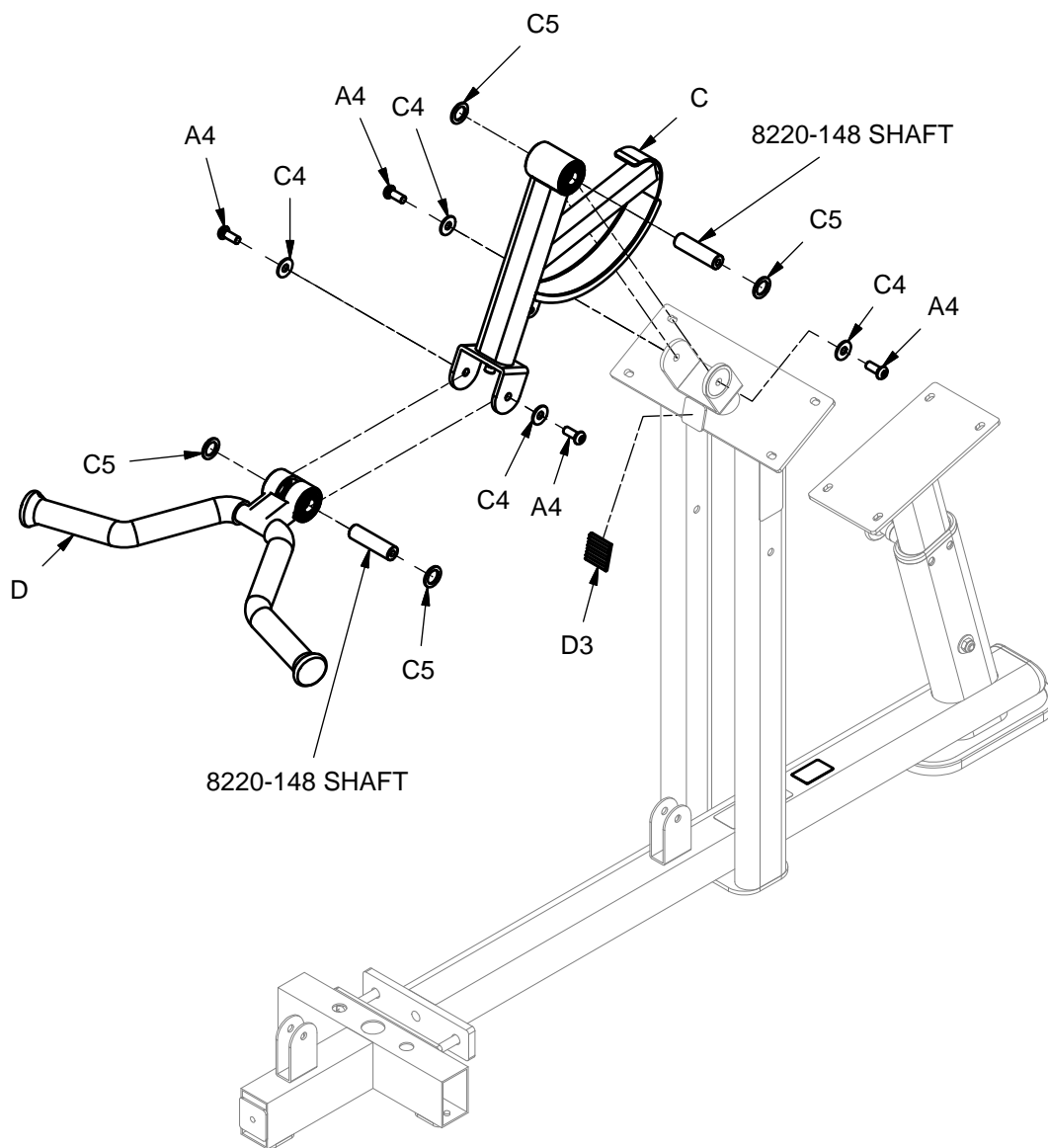

# HBC-600 ASSEMBLY INSTRUCTIONS

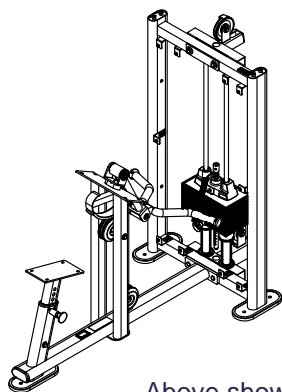

Above shows STEP 5 assembled and completed

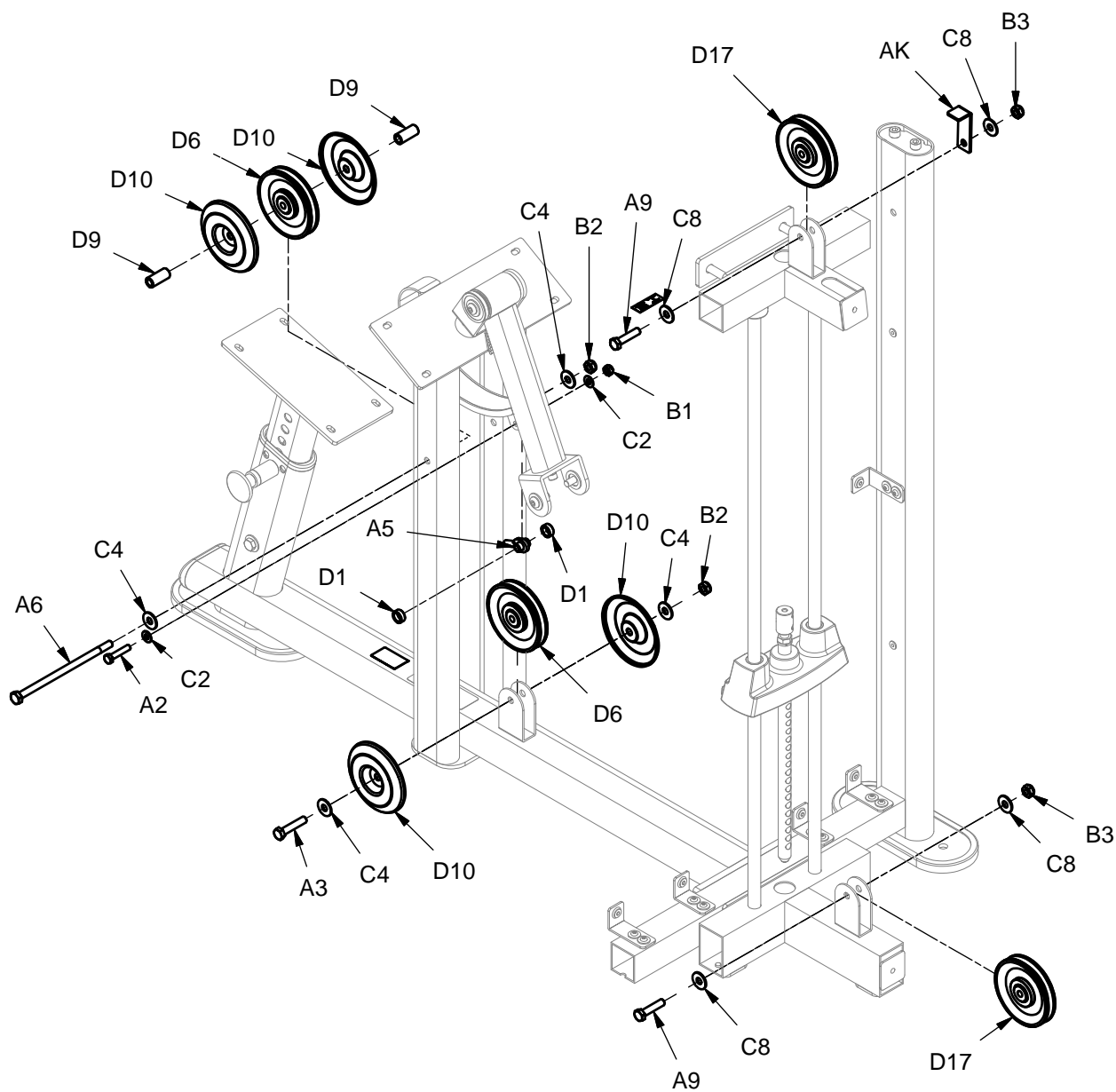



# HBC-600 ASSEMBLY INSTRUCTIONS

## Cable to constitute illustration

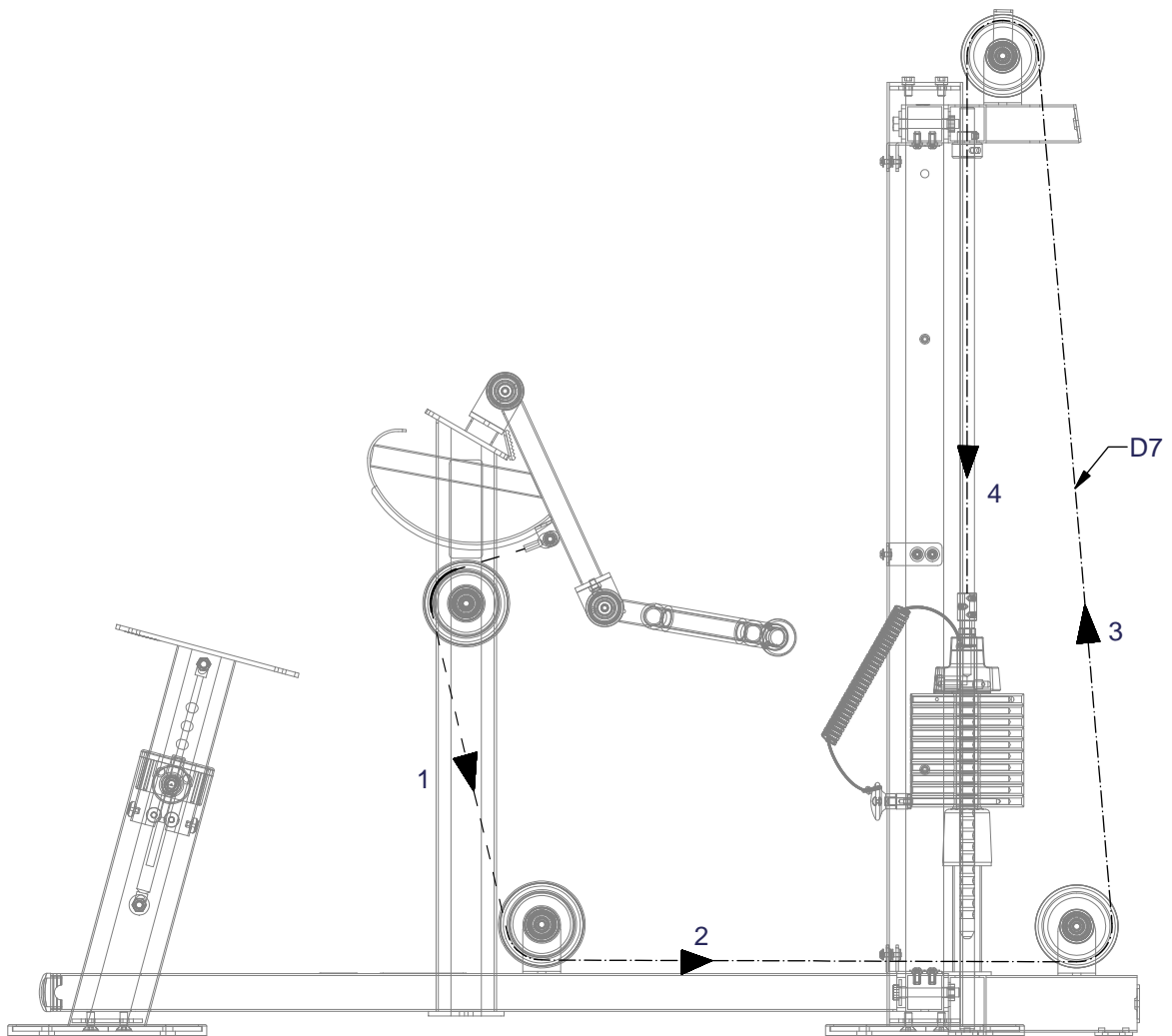

# HBC-600 ASSEMBLY INSTRUCTIONS

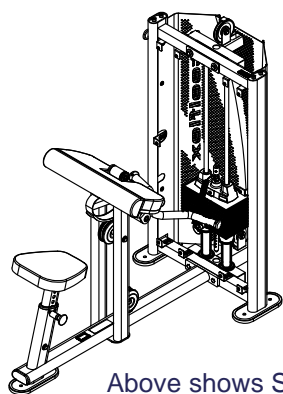

Above shows STEP 6  
assembled and completed

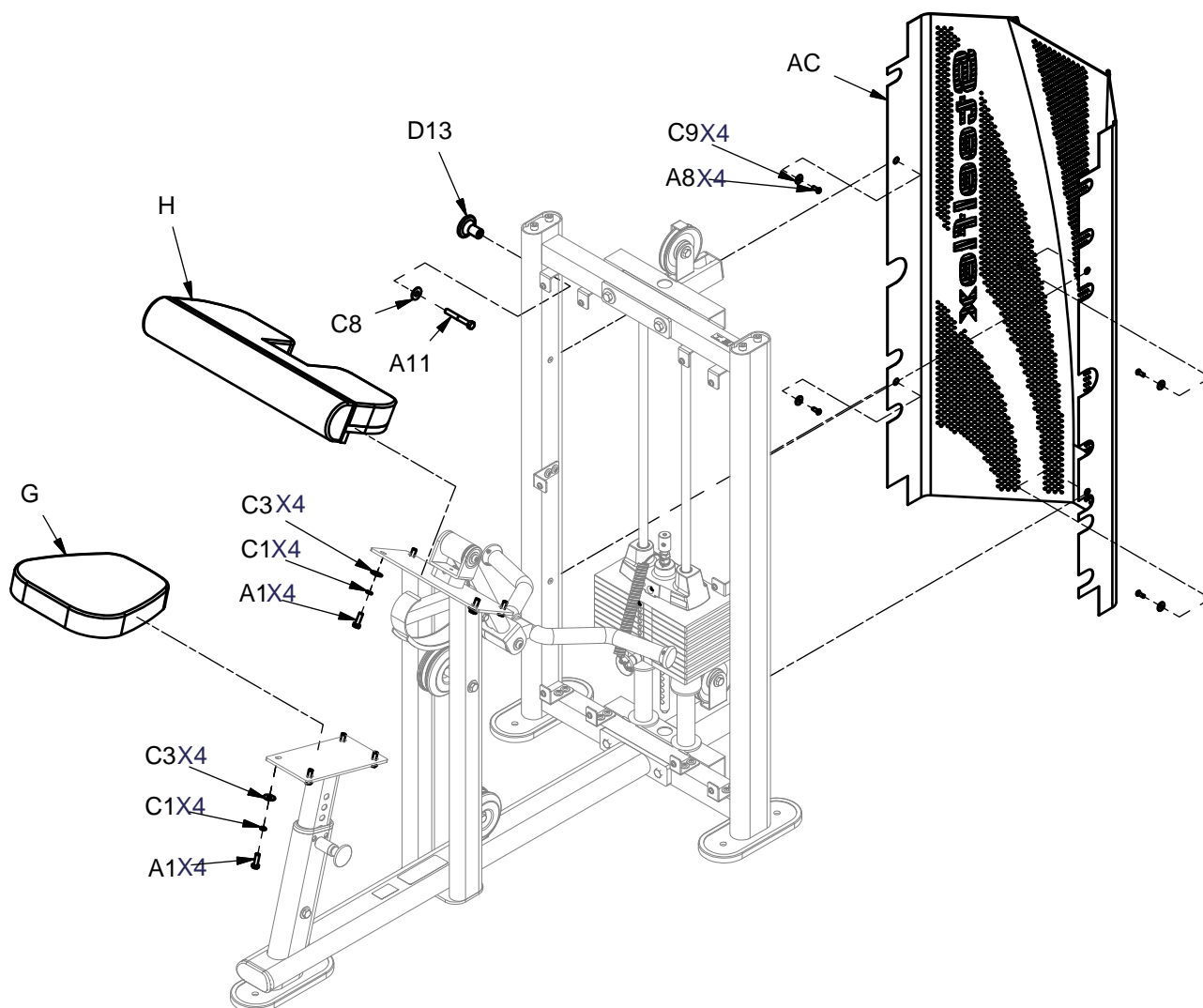

# HBC-600 ASSEMBLY INSTRUCTIONS

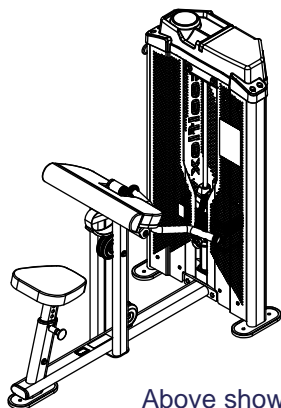

Above shows STEP 7  
assembled and completed

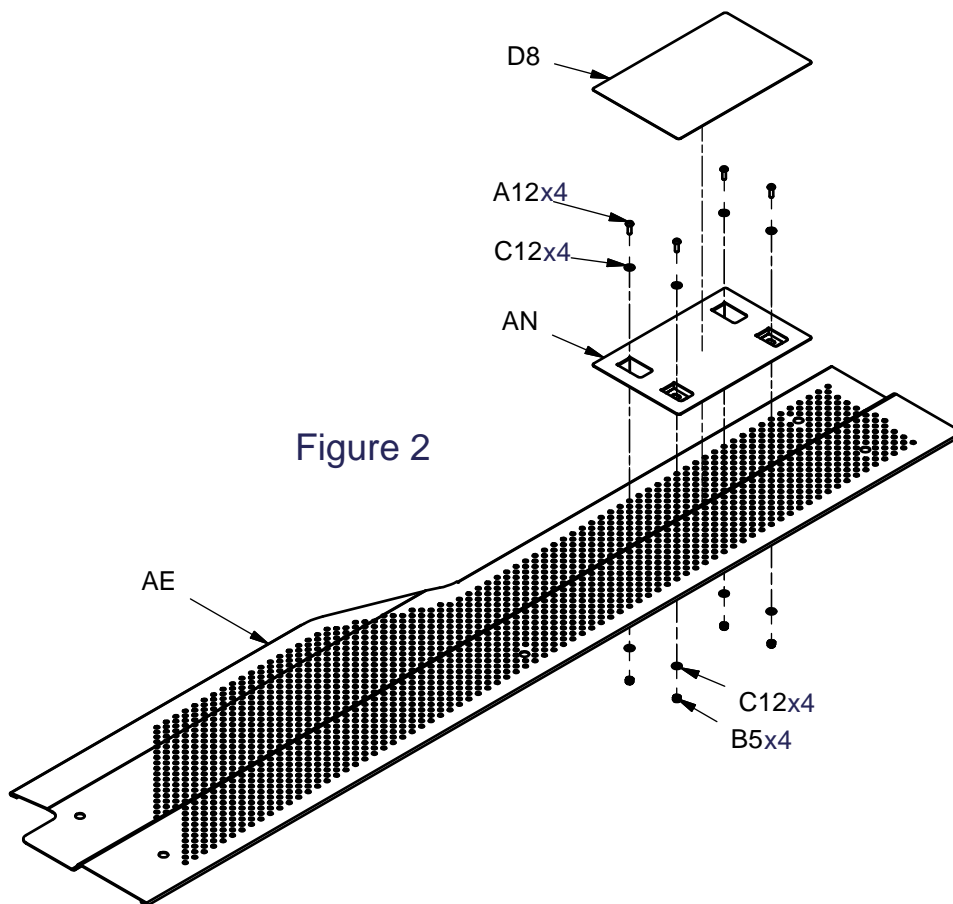
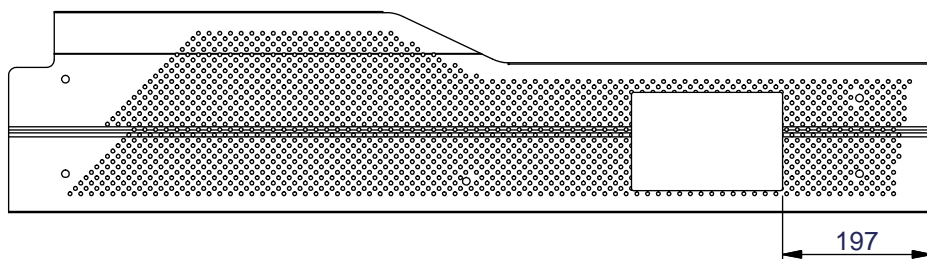
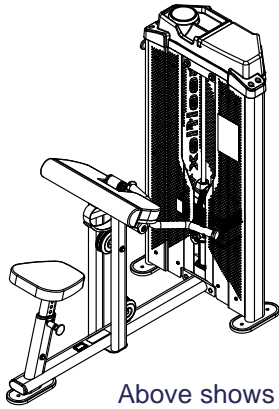
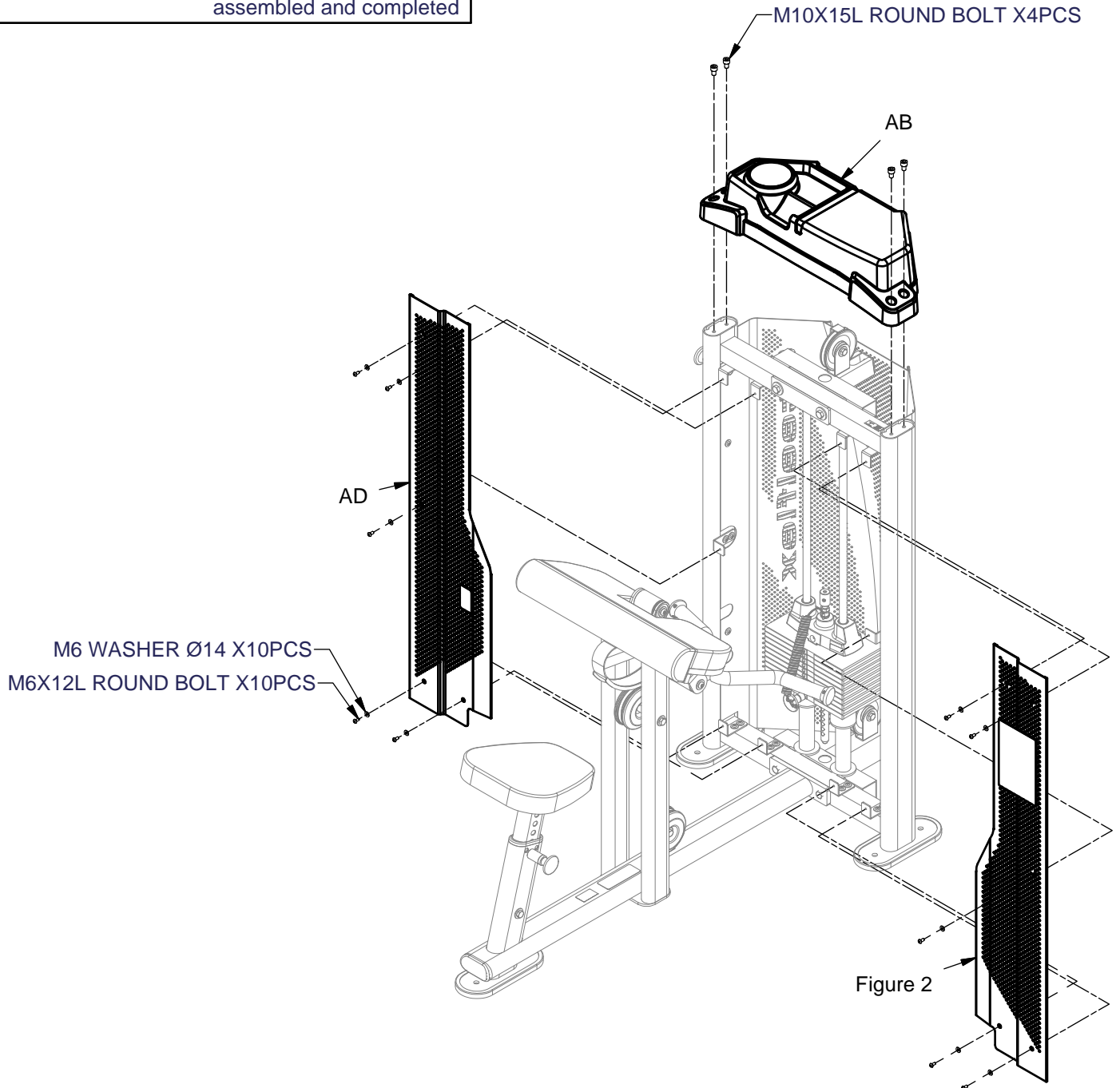

Figure 2

# HBC-600 ASSEMBLY INSTRUCTIONS



Above shows STEP 7  
assembled and completed



# HOPE ASSEMBLY INSTRUCTIONS

## DECAL REFERENCE

MAINTENANCE SCHEDULE		DAILY		WEEKLY	
Check the function and integrity of the following components. As noted, inspect equipment before each workout. Replace all damaged, broken or worn components immediately.					
Cables:	Check tension, end fittings, and coating	✓		✓	
	Check that locking nut at weight stack is tight		✓		✓
Upholstery:	Wipe down and dry	✓		✓	
	Clean and condition		✓		✓
Frame:	Wipe down and dry	✓		✓	
	Polish / Wax		✓		✓
Chrome:	Wipe down and dry	✓		✓	
	Polish / Lubricate		✓		✓
Nut / Bolts / Fasteners:	Tighten and / or adjust as needed		✓		✓
Guide Rods:	Lubricate and clean		✓		✓
Linear Rods:	Lubricate and clean		✓		✓
Seat Sleeves:	Lubricate and clean		✓		✓
Adjustments / Locking Pins / Tightening Knobs			✓		✓
Weight Stack Pins			✓		✓
Warning Instruction Labels			✓		✓
Springs / Pop Pins		✓			
Anti Skid Surfaces			✓		
Hand Grips / Rollers			✓		
For Steelflex Customer Service Call +886 2 27209980					

**THERE IS A RISK ASSUMED BY INDIVIDUALS WHO USE THIS TYPE OF EQUIPMENT. TO MINIMIZE RISK, YOU MUST FOLLOW THESE RULES:**

1. Inspect equipment before each workout. Check that all nuts, bolts, screws and pop pins are in place and fully tightened. Also, before use, check cables for signs of wear. Replace all worn parts immediately. Never use machine if any parts are damaged or missing. **FAILURE TO FOLLOW THESE RULES MAY RESULT IN SERIOUS INJURY.**
2. Keep clear of the cables and all moving parts when the machine is in use.
3. Always make sure all Snap Links are closed when doing any cable/pulley/strap exercises.
4. Exercise with care. Perform your exercises at a smooth moderate pace; never perform jerky or uncoordinated movements that may cause injury.
5. It is recommended that you should workout with a training partner.
6. Do not allow children or minors to play on or around this equipment.
7. If unsure of proper use of equipment, call Steelflex Customer Service +886 2 27209980.
8. **WARNING:** Consult your physician before starting your exercise program. For your own safety, do not begin any exercise program without proper instruction.

### 9440-259



### 9440-258

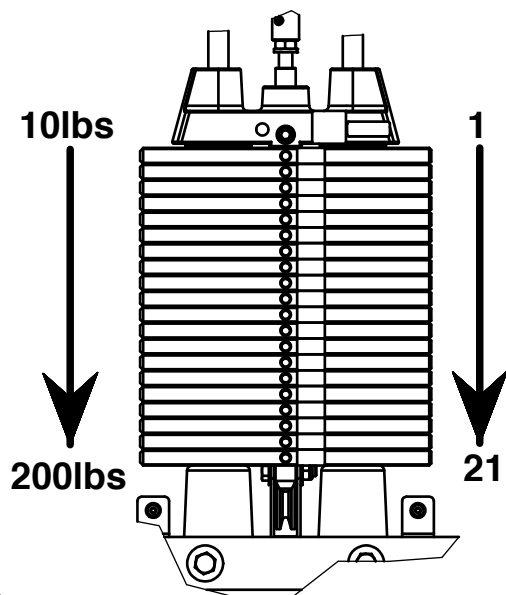

### 9440-417

### 9440-418

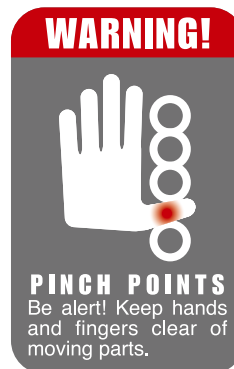

### 9440-117